

**Fall Fling 2022
Pattern Book**

Western Riding

Green/Novice – Level 1 - 2

All Others – Regular - 2

Reining

Pattern 10

Ranch Riding

Pattern 2

2022 Fall Special
Event 8-26-2022

ALL TRAIL CLASSES
XCEPT SMALL FRY /
WT / EWD

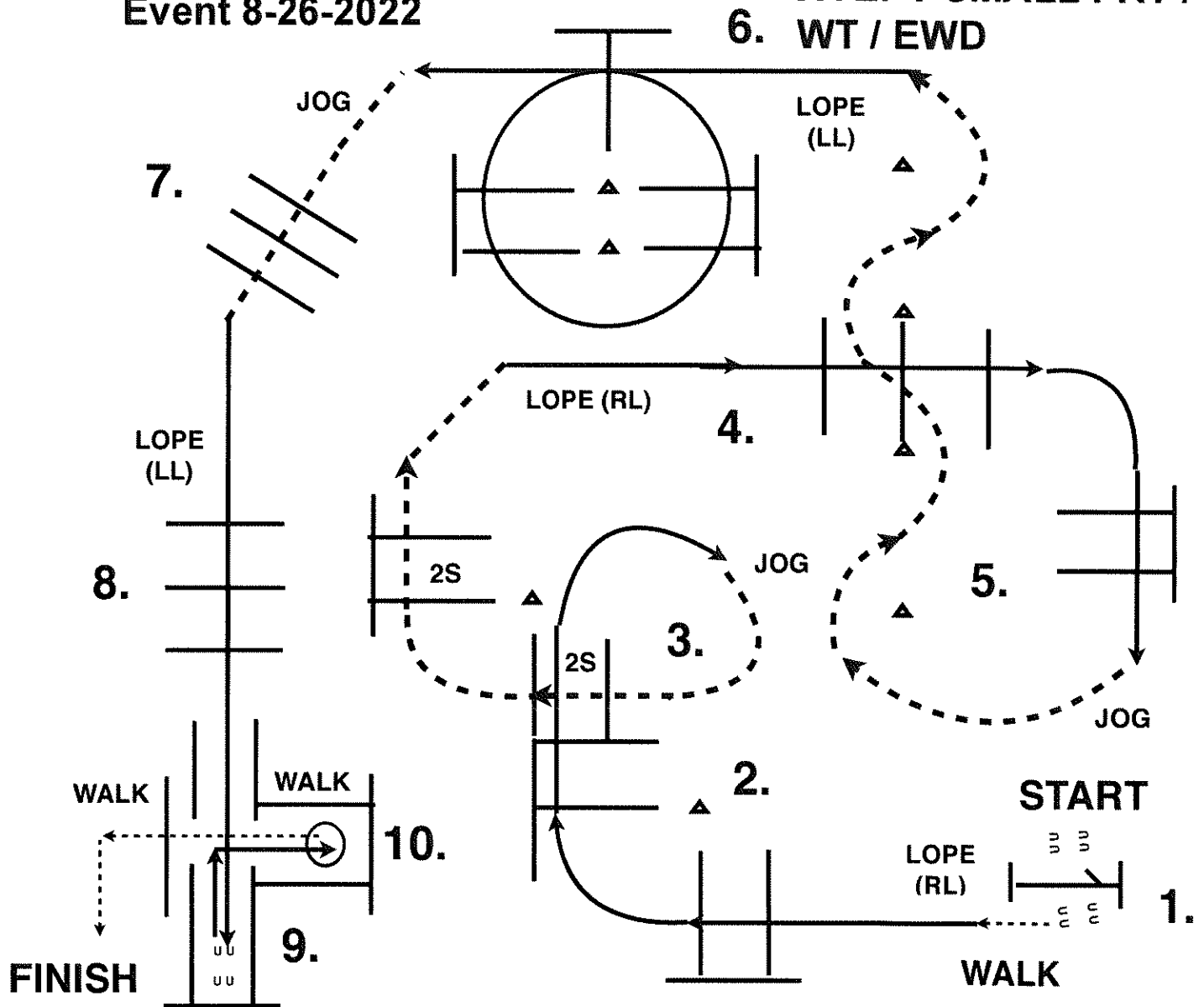

1. GATE: RH OPEN, WALK OVER POLE, CLOSE GATE.
2. WALK FORWARD, THEN LOPE OVER POLES (RL).
3. BREAK TO THE JOG, JOG OVER POLES.
4. LOPE OVER POLES (RL)
5. BREAK TO THE JOG, JOG OVER POLE
JOG THRU SERPENTINE.
6. LOPE OVER POLES (LL).
7. BREAK TO THE JOG, JOG OVER POLES.
8. LOPE OVER POLES (LL), LOPE INTO CHUTE.
9. BACK BETWEEN POLES AND INTO BOX.
10. EXECUTE A 360 TURN EITHER WAY.
WALK OUT BOX, WALK OVER POLES.

2022 Fall Special
Event 8-26-2022

TRAIL CLASSES
SMALL FRY / WT /
EWD

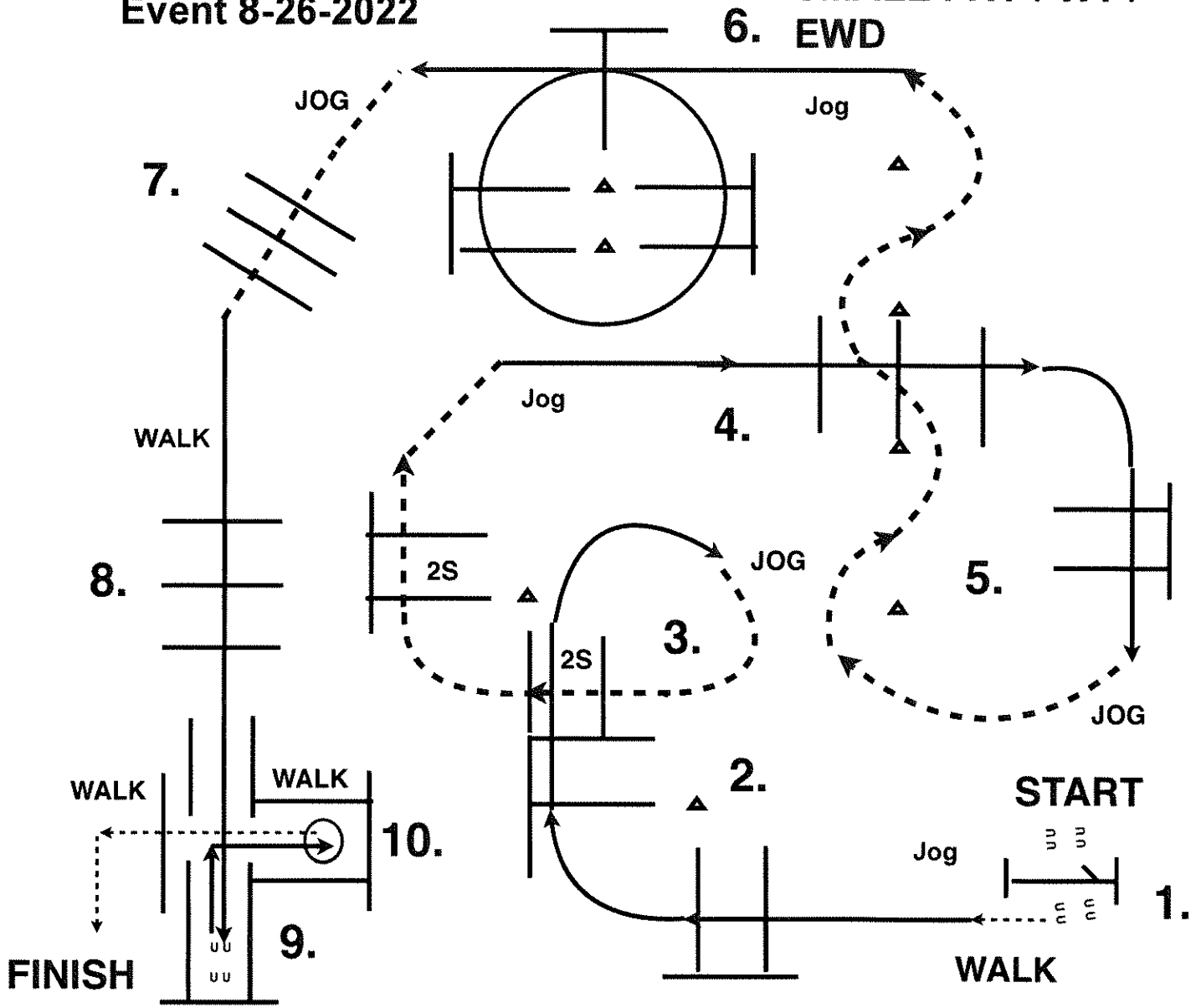

1. GATE: RH OPEN, WALK OVER POLE, CLOSE GATE.
2. WALK FORWARD, THEN JOG OVER POLES.
3. JOG OVER POLES.
4. JOG OVER POLES
5. JOG OVER POLE
JOG THRU SERPENTINE.
6. JOG OVER POLES
7. JOG OVER POLES.
8. WALK OVER POLES, WALK INTO CHUTE.
9. BACK BETWEEN POLES AND INTO BOX.
10. EXECUTE A 360 TURN EITHER WAY.
WALK OUT BOX, WALK OVER POLES.

Fall Fling 2022

Showmanship (All Level 1) *Rockie*

Show Date: _____

w w w . H o r s e S h o w P a t t e r n s . c o m

w w w . H o r s e S h o w P a t t e r n s . c o m

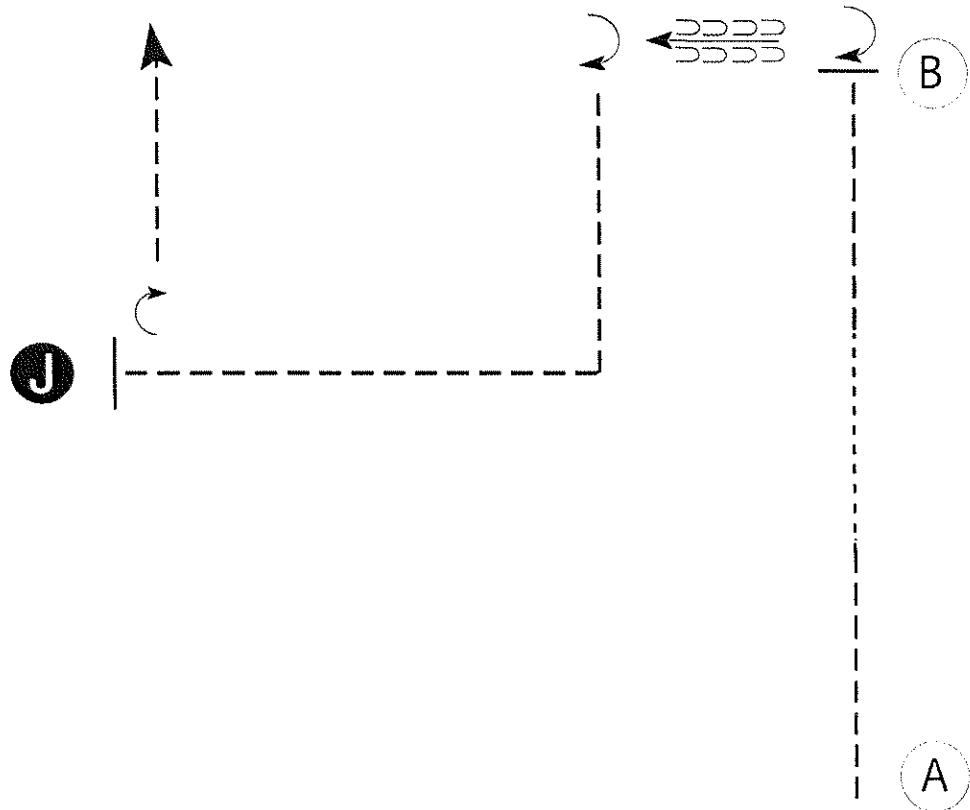

Be ready at A.

1. Trot 1/3 of the line, then walk 1/3 of the line then trot the final 1/3 of the line.
2. Stop with horse's hip even with B then perform a 1/4 turn.
3. Back 2 horse lengths then perform a 1/4 turn.
4. Trot to judge as shown.
5. Stop and set up at Judge.
6. Inspection.
7. When dismissed, perform a 1/4 turn and trot to exit.

Walk -----
Trot - - - - -
Back ← - - - - -
Marker (B)
Judge (J)

[S/1-119]

Pattern Provided by:

HorseShowPatterns.com

Fall Fling 2022

Showmanship (Amateur and Youth)

Show Date _____

www.HorseShowPatterns.com

www.HorseShowPatterns.com

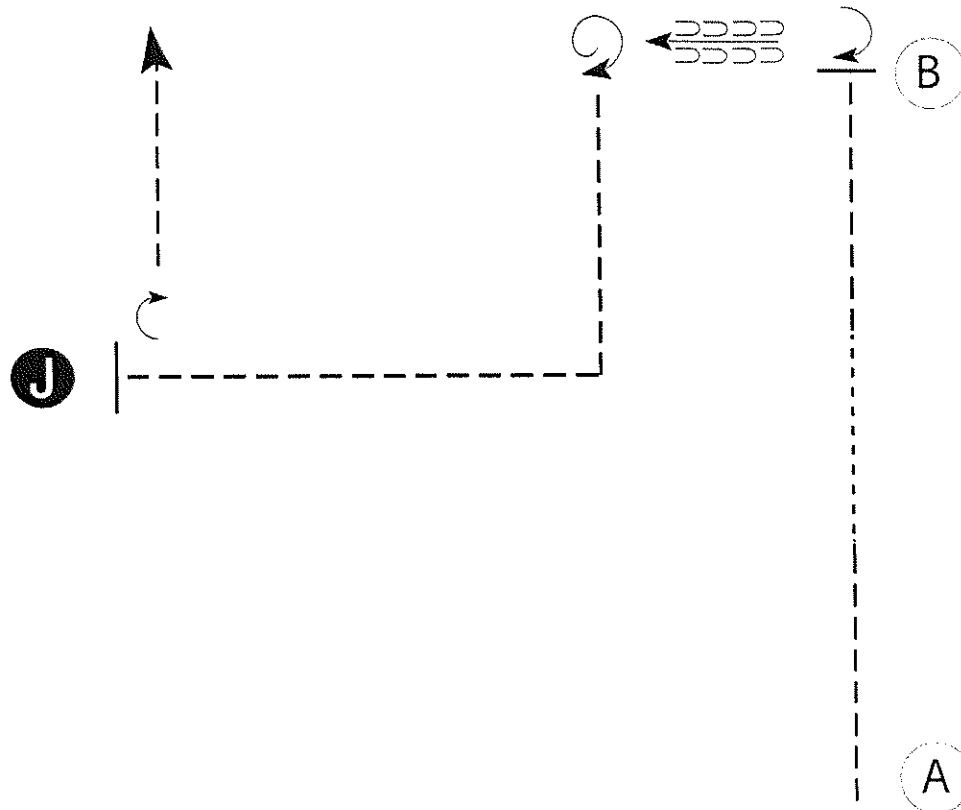

Be ready at A.

1. Trot 1/3 of the line, then walk 1/3 of the line then trot the final 1/3 of the line.
2. Stop with horse's hip even with B then perform a 1/4 turn.
3. Back 2 horse lengths then perform a 1 1/4 turn.
4. Trot to judge as shown.
5. Stop and set up at Judge.
6. Inspection.
7. When dismissed, perform a 1/4 turn and trot to exit.

Walk -----
Trot - - - - -
Back ← ← ← ← ←
Marker (B)
Judge (J)

[S/2-119]

Pattern Provided by:

HorseShowPatterns.com

Fall Fling 2022

Showmanship (All Walk / Trot) Small fry

Show Date: _____

www.horsecshowpatterns.com

www.horsecshowpatterns.com

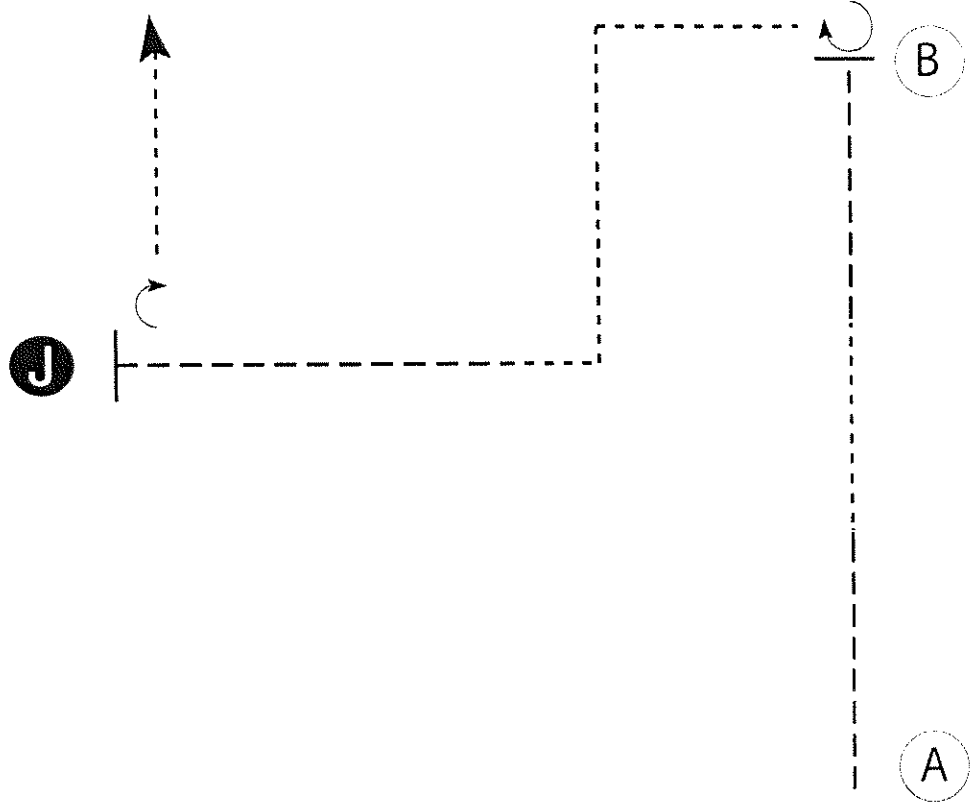

Be ready at A.

1. Trot 1/3 of the line, then walk 1/3 of the line then trot the final 1/3 of the line.
2. Stop with horse's hip even with B.
3. Perform a 3/4 turn.
4. Walk two square corners as shown then trot to judge.
5. Stop and set up at Judge.
6. Inspection.
7. When dismissed, perform a 1/4 turn and walk to exit.

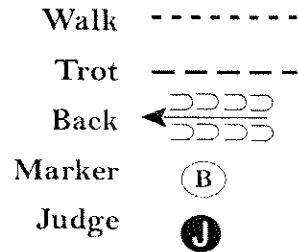

[SWT-119]

Pattern Provided by:

HorseShowPatterns.com

Fall Fling 2022

Western Horsemanship (All Level 1) *Rookie*

Show Date: _____

www.HorseShowPatterns.com

www.HorseShowPatterns.com

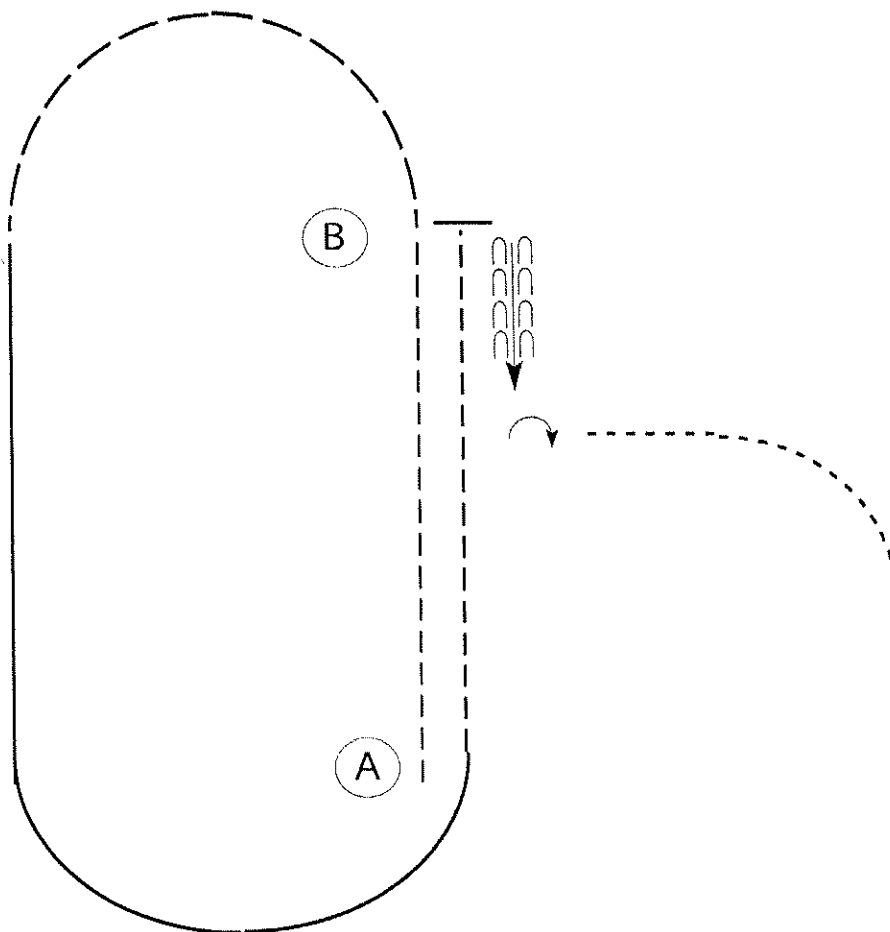

Be ready at A.

1. Jog from A to B.
2. Extend the jog in a half circle.
3. Lope on the left lead until even with A.
4. Jog to B.
5. Stop, back one horse length and perform a 90 degree turn to the right.
6. Pattern is complete. Exit at the walk.

| | |
|--------------|---------|
| Walk | |
| Jog | ----- |
| Extended Jog | ----- |
| Lope | ———— |
| Lead Change | ———/——— |
| Back | ←——— |
| Marker | ⓑ |

[WH/1-109]

Pattern Provided by:

HorseShowPatterns.com

Fall Fling 2022

Western Horsemanship (Amateur and Youth)

Show Date: . . .

w w w . H o r s e S h o w P a t t e r n s . c o m

H o r s e S h o w P a t t e r n s . c o m

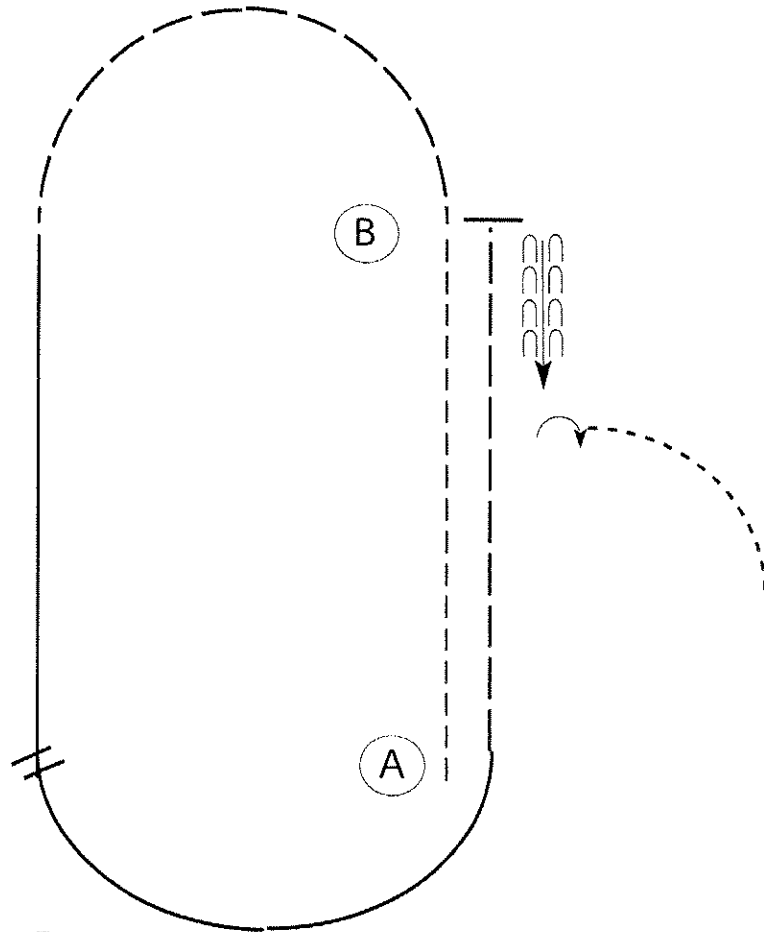

Be ready at A.

1. Jog from A to B.
2. Extend the jog in a half circle.
3. Lope on the right lead until even with A.
4. Perform a simple lead change.
5. Lope on the left lead until even with A.
6. Extend the jog to B.
7. Stop, back one horse length and perform a 90 degree turn to the right.
8. Pattern is complete. Exit at the walk

| | |
|--------------|-----------|
| Walk | ----- |
| Jog | - - - - - |
| Extended Jog | — — — — |
| Lope | ————— |
| Lead Change | |
| Back | |
| Marker | Ⓚ |

[WH/2-109]

Pattern Provided by:

HorseShowPatterns.com

Fall Fling 2022

Western Horsemanship (All Walk / Trot) *Small Fry*

Show Date: _____

W W W . H O R S E S H O W P A T T E R N S . C O M

W W W . H O R S E S H O W P A T T E R N S . C O M

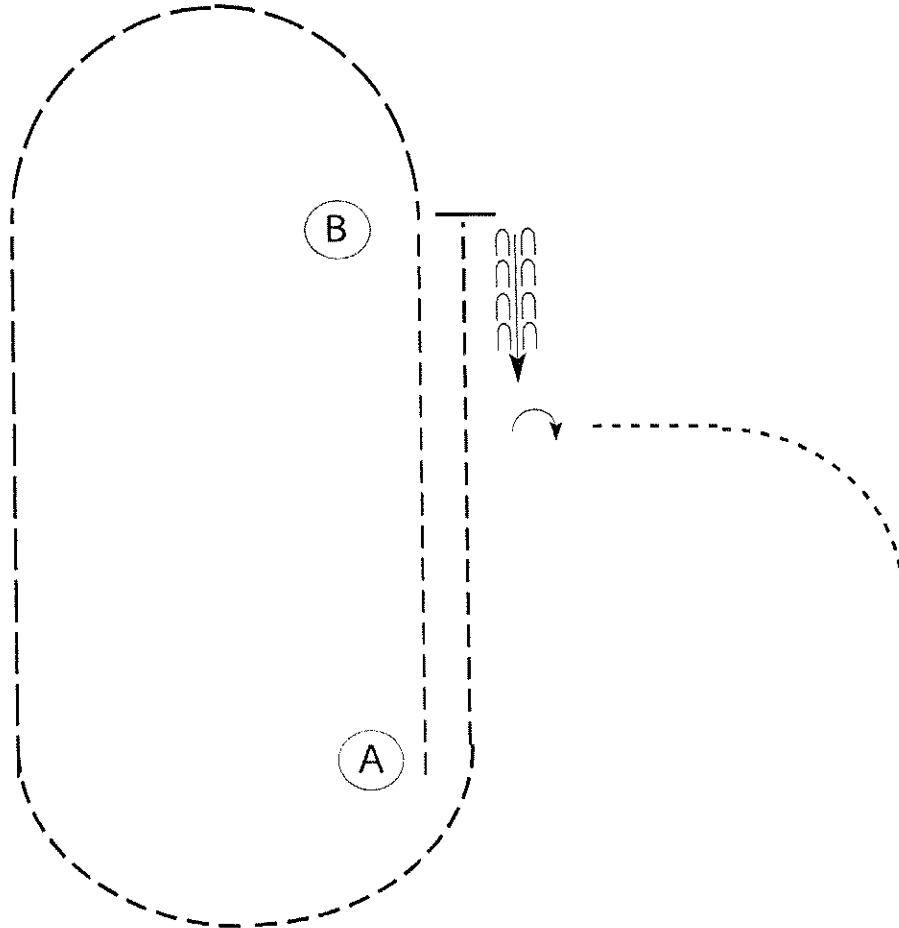

Be ready at A.

1. Jog from A to B.
2. Extend the jog in a half circle.
3. Continue the extended jog on a straight line until even with A.
4. Jog a half circle then a straight line to B.
5. Stop, back one horse length and perform a 90 degree turn to the right.
6. Pattern is complete. Exit at the walk.

| | |
|--------------|-------|
| Walk | |
| Jog | ----- |
| Extended Jog | ----- |
| Lope | ————— |
| Lead Change | ——/—— |
| Back | ←——— |
| Marker | ⊙ B |

[WH/WT-109]

Pattern Provided by:

HorseShowPatterns.com

Fall Fling 2022

Hunt Seat Equitation (All Level 1) Rookie

Show Date

W W W . H O R S E S H O W P A T T E R N S . C O M

W W W . H O R S E S H O W P A T T E R N S . C O M

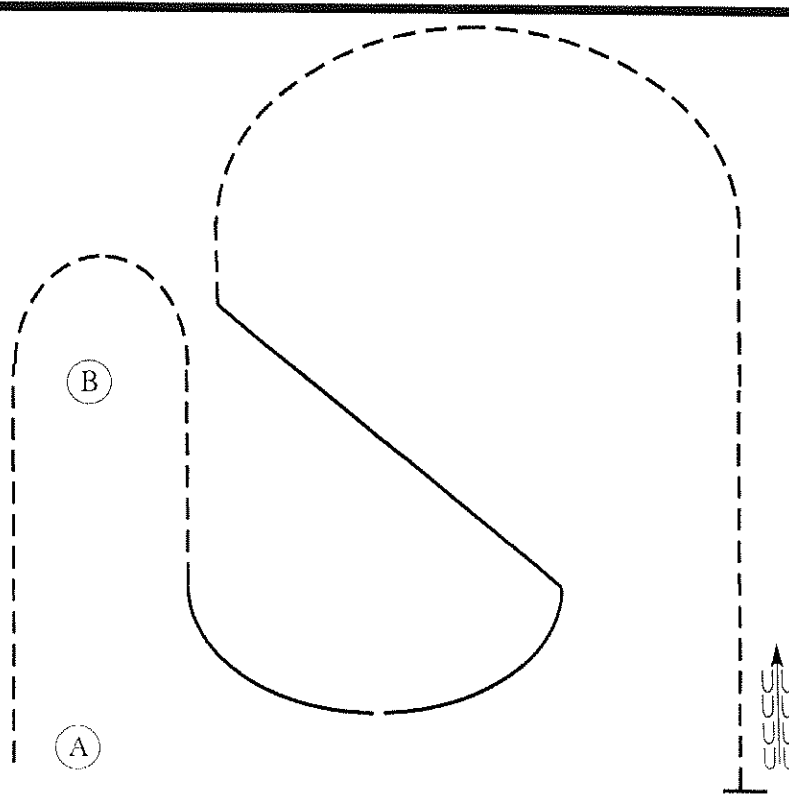

Be ready at A.

1. Begin at the trot on the right diagonal, change diagonals 1/2 way between A and B and continue around B.
2. Sitting trot from B to 1/2 way to A.
3. Canter on the left lead in a half circle and on the diagonal.
4. Break to trot on the left diagonal in a half circle.
5. Sitting trot until even with A.
6. Stop and back one horse length.
7. Pattern is complete. Exit at a sitting trot.

| | |
|---------------|-----------|
| Walk | ----- |
| Trot | - - - - - |
| Extended Trot | — — — — — |
| Canter | ————— |
| Leg Yield | |
| Lead Change | ↙ |
| Back | ←←←←← |
| Marker | ⊙ B |
| Sidepass | ←←←←← |
| Hand Gallop | — — — — — |

[HSE/1-81]

Pattern Provided by:

HorseShowPatterns.com

Fall Fling 2022

Hunt Seat Equitation (Amateur and Youth)

Show Date: _____

www.HorseShowPatterns.com

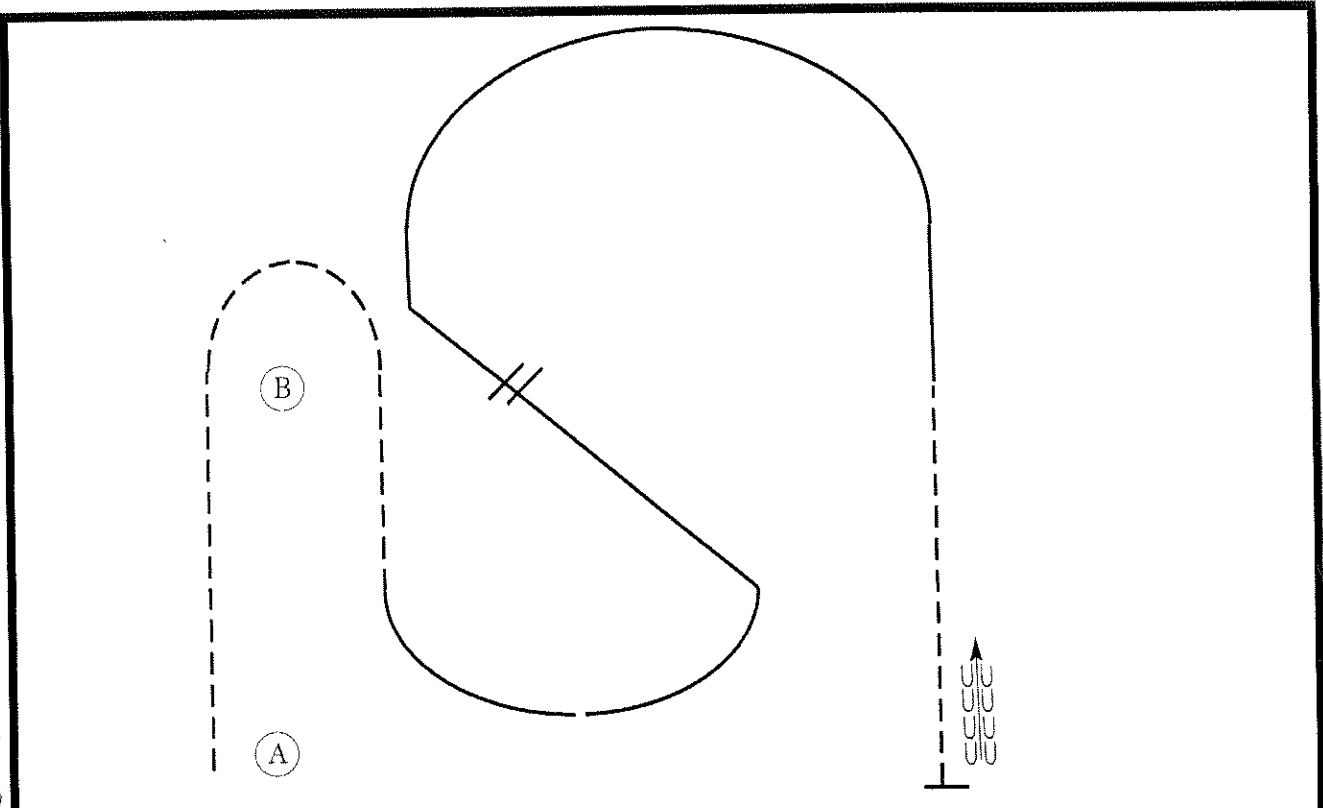

Be ready at A.

1. Begin at the trot on the right diagonal, change diagonals 1/2 way between A and B and continue around B.
2. Sitting trot from B to 1/2 way to A.
3. Canter on the left lead and change leads, simple or flying, across from B.
4. Continue the canter around until even with B.
5. Break to a trot and continue until even with A.
6. Stop and back one horse length.
7. Pattern is complete. Exit at a sitting trot.

| | |
|---------------|-----------|
| Walk | ----- |
| Trot | - - - - - |
| Extended Trot | ----- |
| Canter | ===== |
| Leg Yield | |
| Lead Change | ↘ |
| Back | ←←←←← |
| Marker | ⊘ |
| Sidepass | ←-----→ |
| Hand Gallop | ----- |

[HSE/2-81]

Pattern Provided by:

Fall Fling 2022

Hunt Seat Equitation (All Walk/Trot) *small fry*

Show Date

www.HorseShowPatterns.com

www.HorseShowPatterns.com

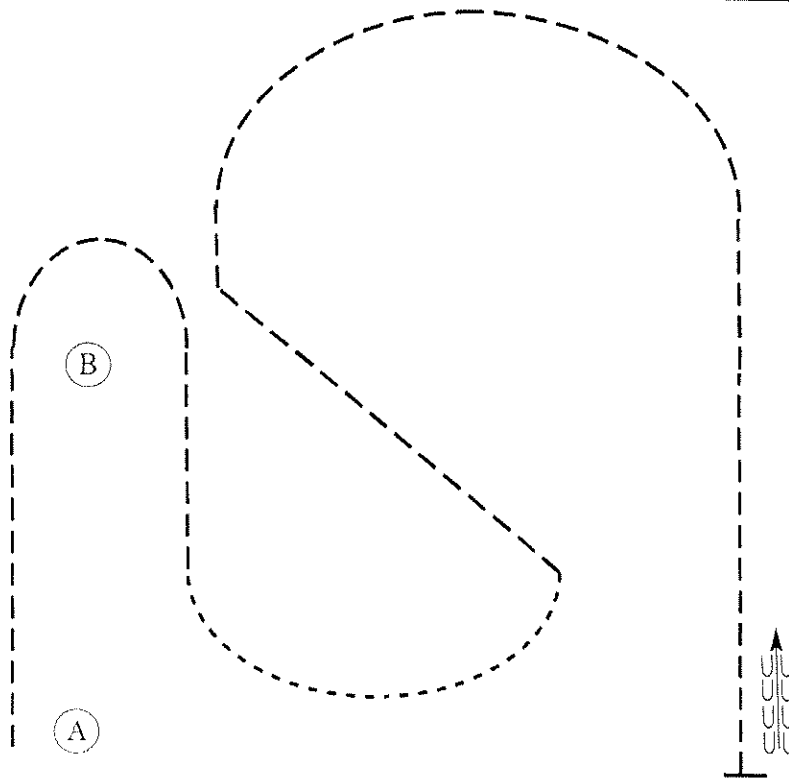

Be ready at A.

1. Begin at the trot on the right diagonal, change diagonals 1/2 way between A and B and continue around B.
2. Sitting trot from B to 1/2 way to A.
3. Walk in a half circle.
4. Sitting trot on the diagonal line.
5. Trot on the left diagonal in a half circle and until even with A.
6. Stop and back one horse length.
7. Pattern is complete. Exit at a sitting trot.

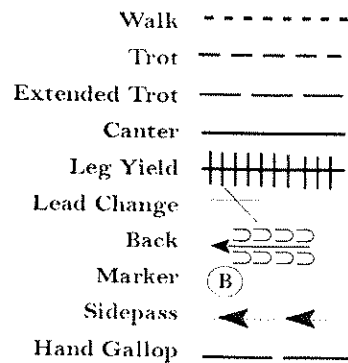

[HSE/WT-81]

Pattern Provided by:

HorseShowPatterns.com

LEVEL I WESTERN RIDING PATTERN 2

LEGEND

| | |
|---------|--------------------|
| | Walk |
| - - - | Jog |
| ———— | Lope |
| /////// | Back |
| | Lead Changing Area |

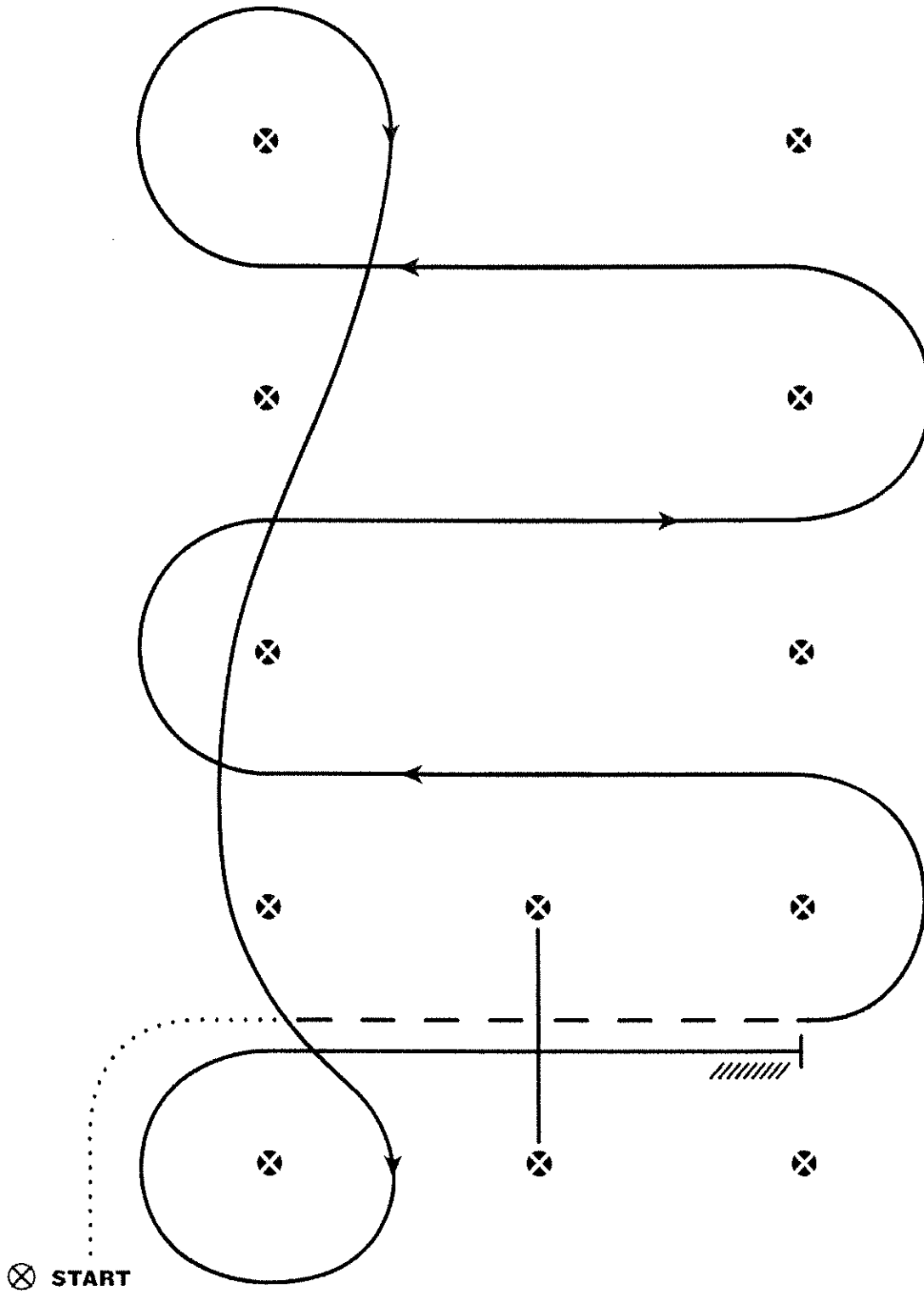

1. Walk at least 15 feet from start cone to the first marker, as drawn, transition to jog, jog over log.
2. Transition to the lope left lead
3. First crossing change
4. Second crossing change
5. Third crossing change
6. Circle & first line change
7. Second line change & circle
8. Lope over log
9. Stop & back

WESTERN RIDING - PATTERN 2

LEGEND

| | |
|---------|--------------------|
| | Walk |
| - - - | Jog |
| ———— | Lope |
| /////// | Back |
| ⊗ | Lead Changing Area |

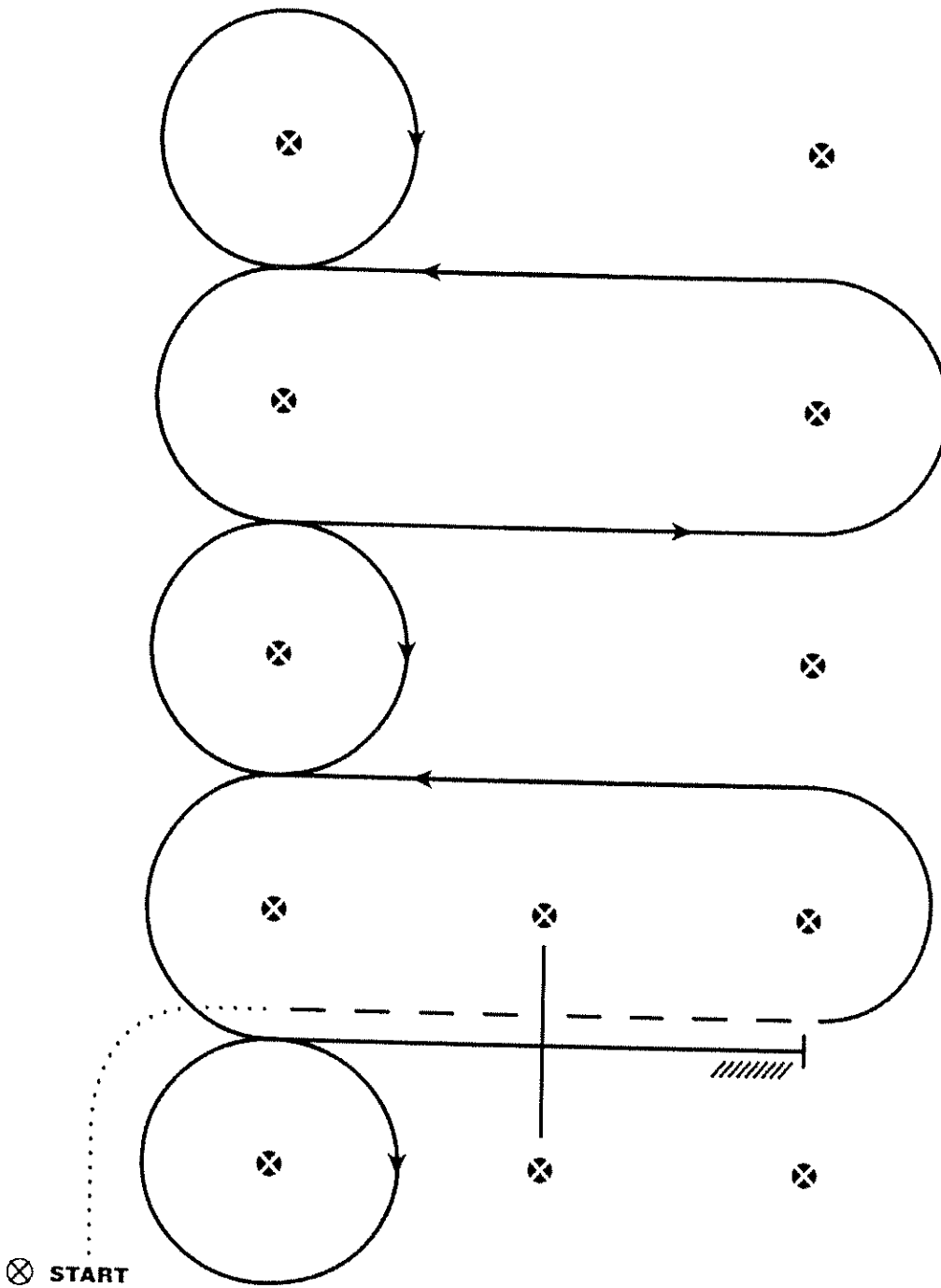

1. Walk at least 15 feet from start cone to the first marker, as drawn, transition to jog, jog over log.
2. Transition to the lope left lead
3. First crossing change
4. Second crossing change
5. Third crossing change
6. Circle & first line change
7. Second line change
8. Third line change
9. Fourth line change & circle
10. Lope over log
11. Lope, stop & back

REINING PATTERN 10

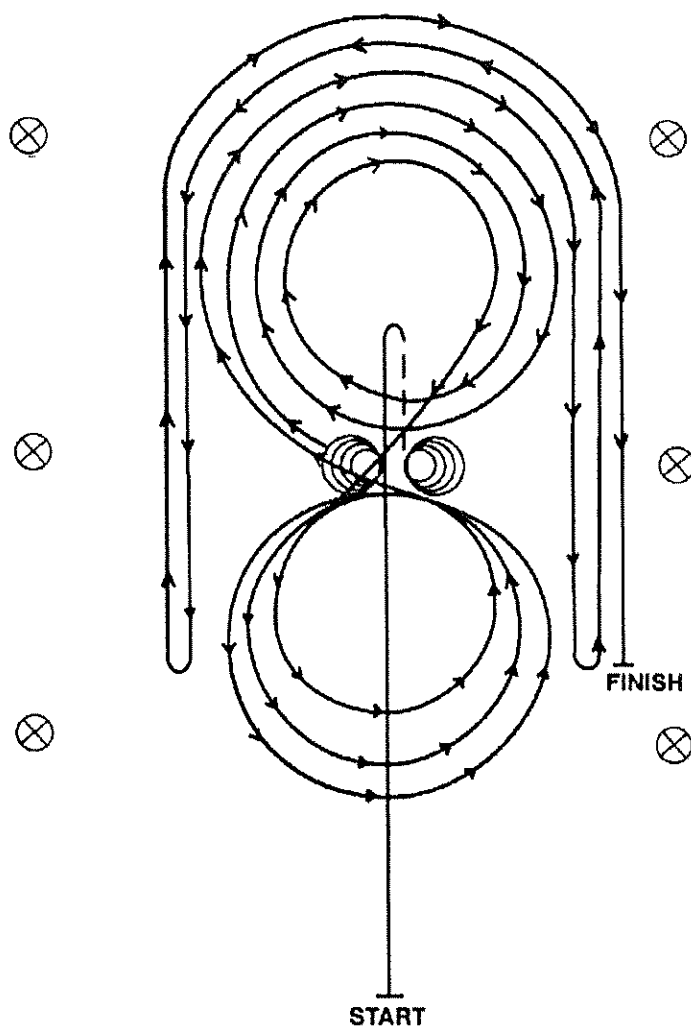

⊗ MARKER

1. Run past the center marker and do a sliding stop. Back up to the center of the arena or at least 10 feet (3 meters). Hesitate.
 2. Complete four spins to the right.
 3. Complete four and one-quarter spins to the left so that the horse is facing the left wall or fence. Hesitate.
 4. Beginning on the right lead, complete three circles to the right: the first two circles large and fast, the third circle small and slow. Change leads at the center of the arena.
 5. Complete three circles to the left: the first circle small and slow, the next two circles large and fast. Change leads at the center of the arena.
 6. Begin a large circle to the right but do not close this circle. Run down the right side of the arena past the center marker and do a left rollback at least 20 feet (6 meters) from the wall or fence - no hesitation.
 7. Continue back around the previous circle but do not close this circle. Run down the left side of the arena past the center marker and do a right rollback at least 20 feet (6 meters) from the wall or fence - no hesitation.
 8. Continue back around previous circle but do not close this circle. Run down the right side of the arena past the center marker and do a sliding stop at least 20 feet (6 meters) from the wall or fence. Hesitate to demonstrate completion of the pattern.
- Rider may dismount and drop the bridle to the designated judge.

RANCH RIDING – PATTERN 2

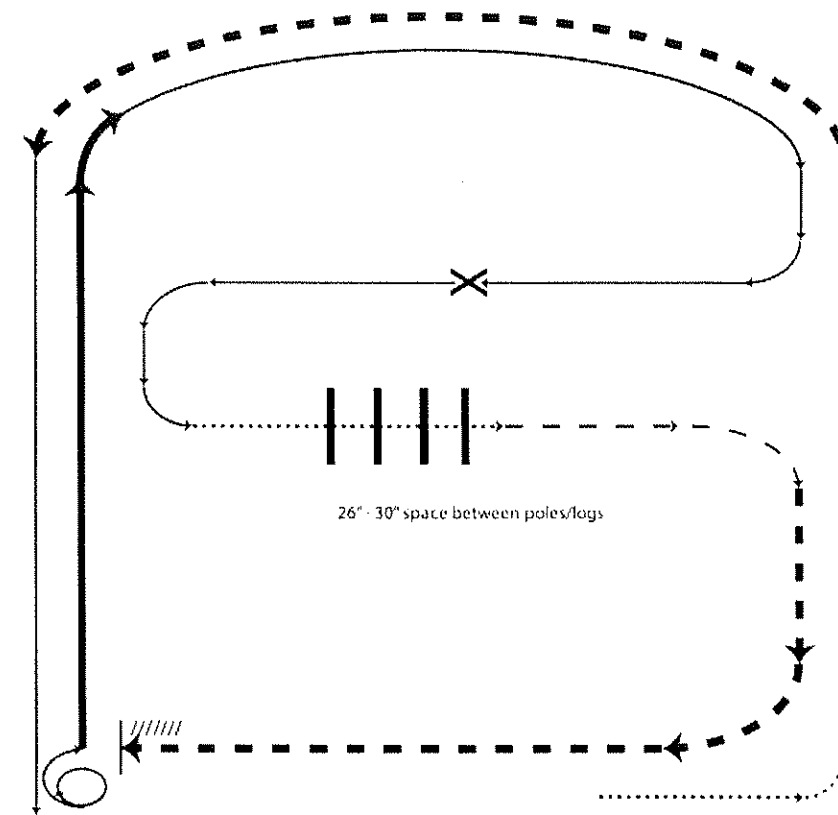

- X Lead Change
- • Walk
- - Trot
- - - Ext Trot
- Lope
- Ext Lope
- //// Back

1. Walk
2. Trot
3. Extended trot
4. Left lead lope
5. Stop, 1/2 turn right
6. Extended lope
7. Collect to working lope-right lead
8. Change leads (simple or flying)
9. Walk
10. Walk over logs
11. Trot
12. Extended trot
13. Stop and back

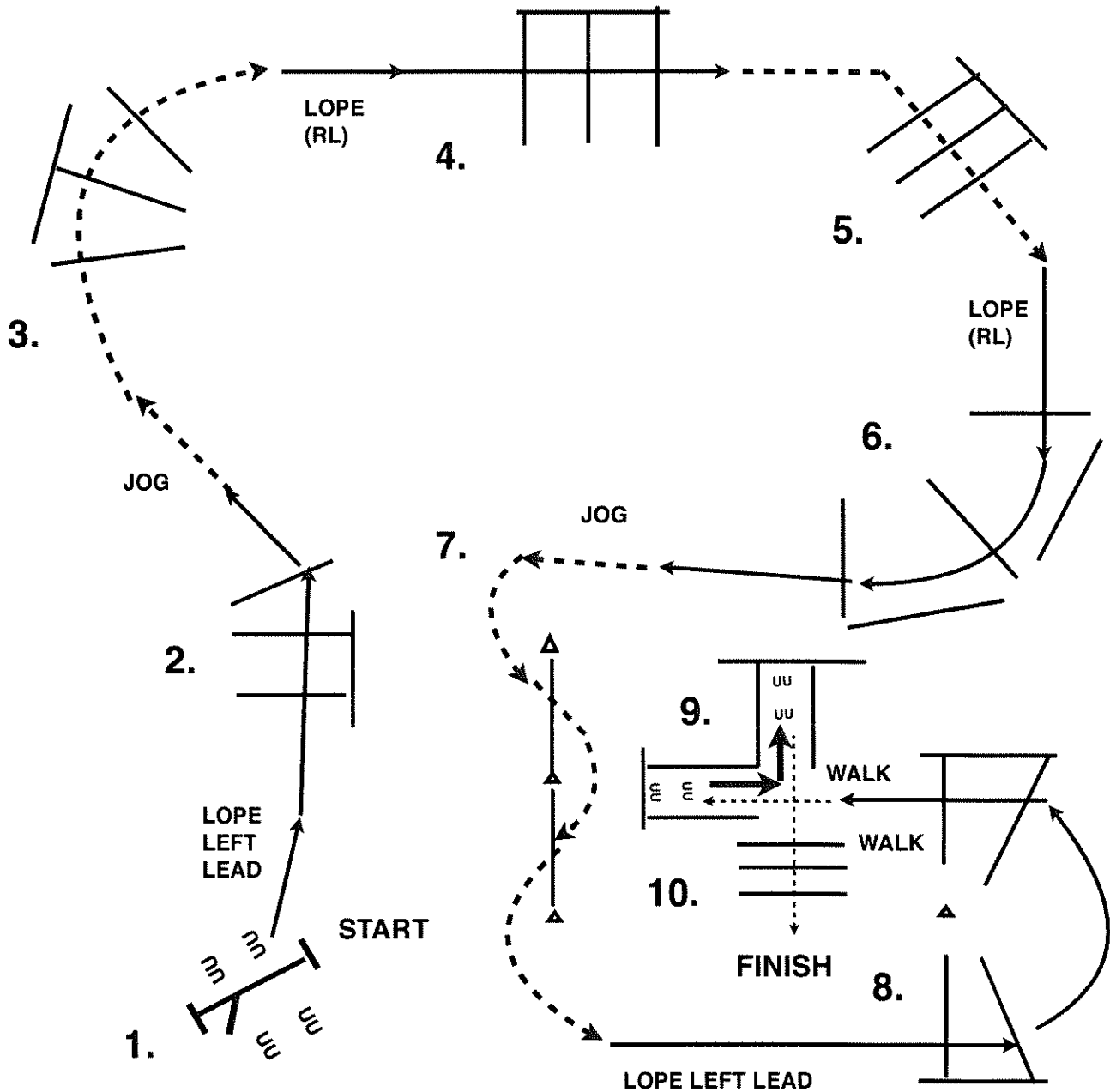

1. GATE RH OPEN, RIDE THRU CLOSE.
2. LOPE OVER POLES (LL)
3. JOG OVER POLES.
4. LOPE OVER POLES (RL)
5. JOG OVER POLES.
6. LOPE OVER POLES (RL)
7. JOG THRU SERPENTINE, JOG OVER POLES.
8. LOPE OVER POLES (LL).
9. STOP OR BREAK TO THE WALK,
WALK INTO CHUTE, BACK AROUND CORNER.
10. WALK OUT CHUTE, WALK OVER POLES.

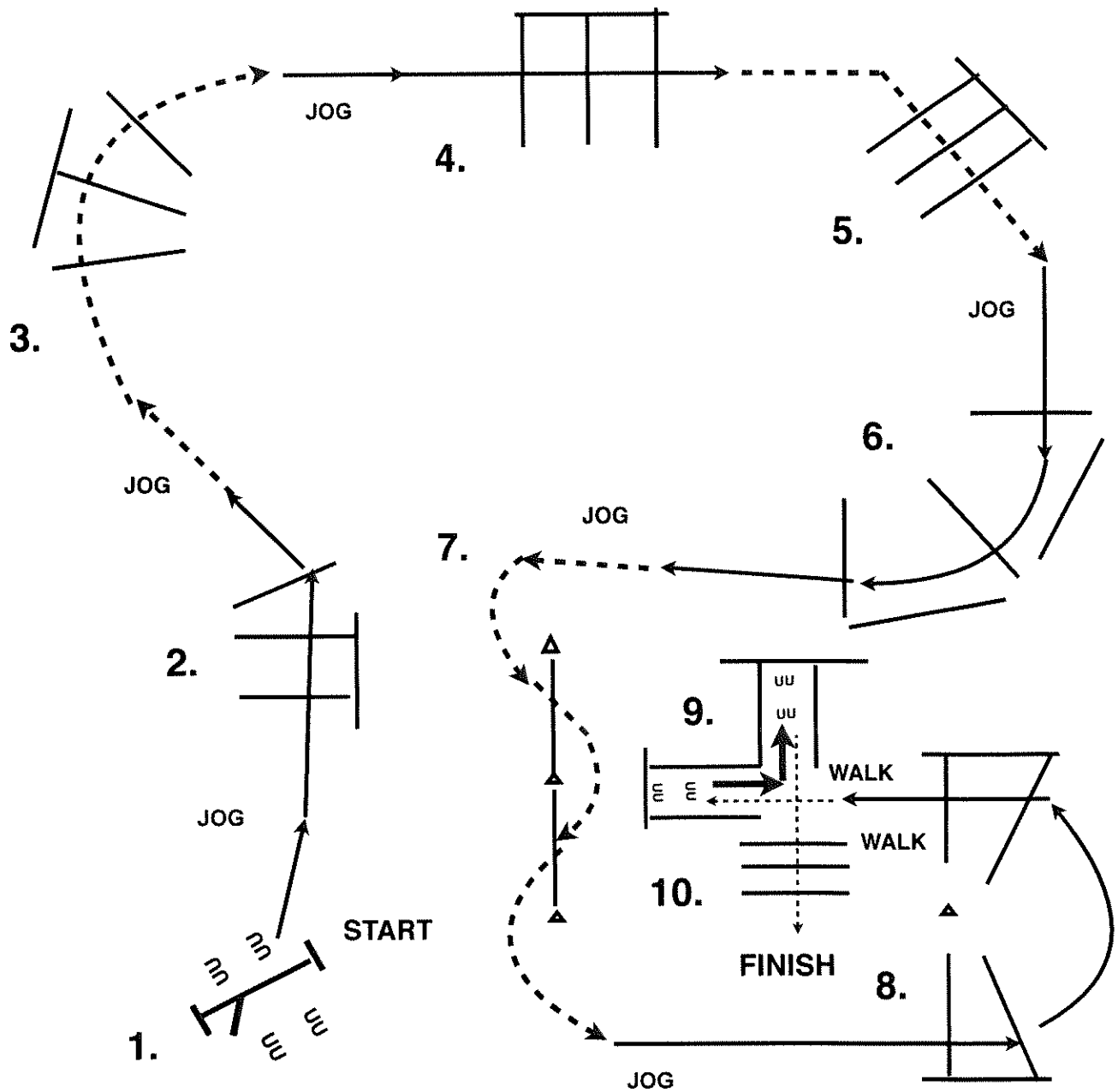

1. GATE RH OPEN, RIDE THRU CLOSE.
2. JOG OVER POLES
3. JOG OVER POLES.
4. JOG OVER POLES
5. JOG OVER POLES.
6. JOG OVER POLES JOG THRU SERPENTINE,
JOG OVER POLES.
7. JOG OVER POLES.
8. STOP OR BREAK TO THE WALK,
WALK INTO CHUTE, BACK AROUND CORNER.
9. WALK OUT CHUTE, WALK OVER POLES.

FOR ALL SHOW

RESULTS:

GO TO:

www.elitehorseshow.com

www.hcsaddleclub.com